

Tools used: gradienter, screwdriver, silicone gun, silicone, spanner, electric drill, 9 aiguille, triangle ruler, hammer

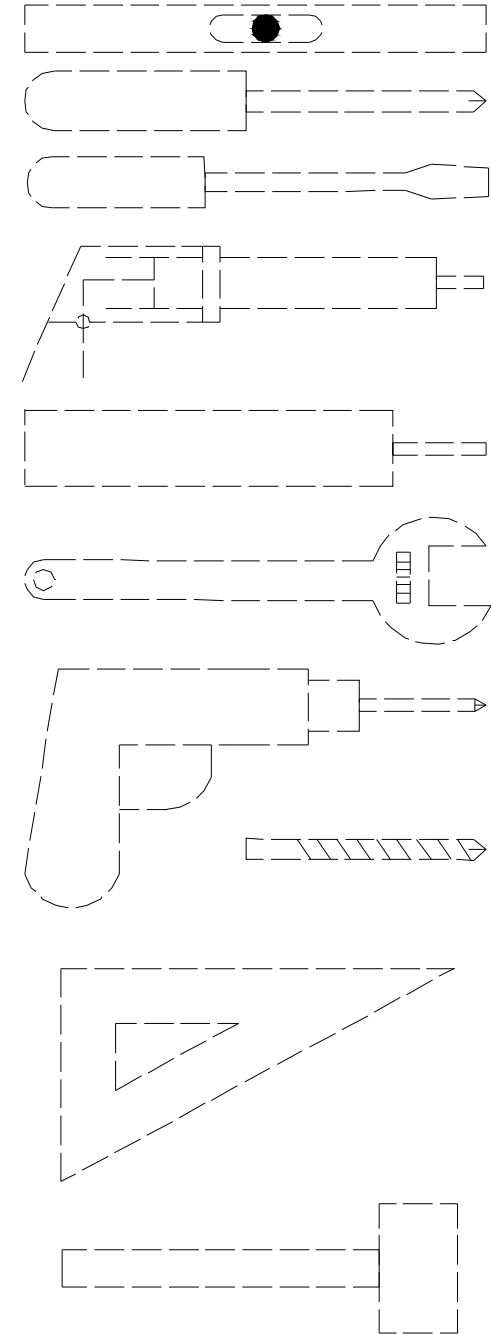

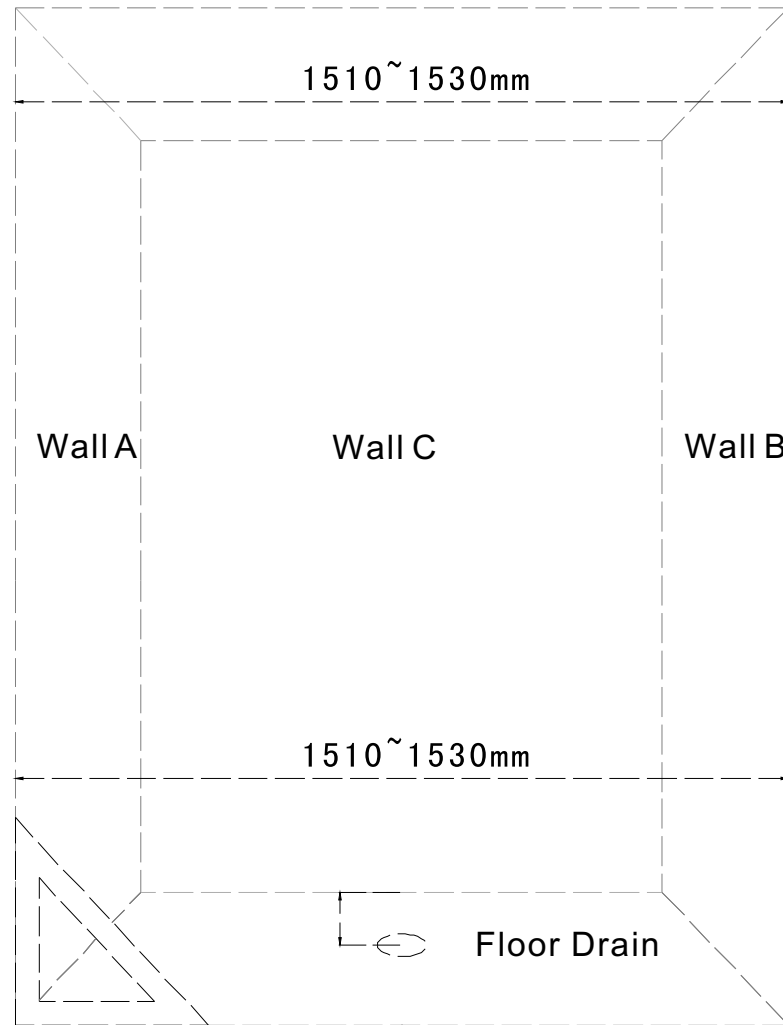

1. Installation place required

The distance between Wall A and Wall B should be within 1510~1530mm. The parallel error between Wall A and Wall B from bottom to 2000mm height should be less than 10mm. If it's bigger than 10mm, please correct the wall. The distance between floor drain and Wall C should be less than 700mm.

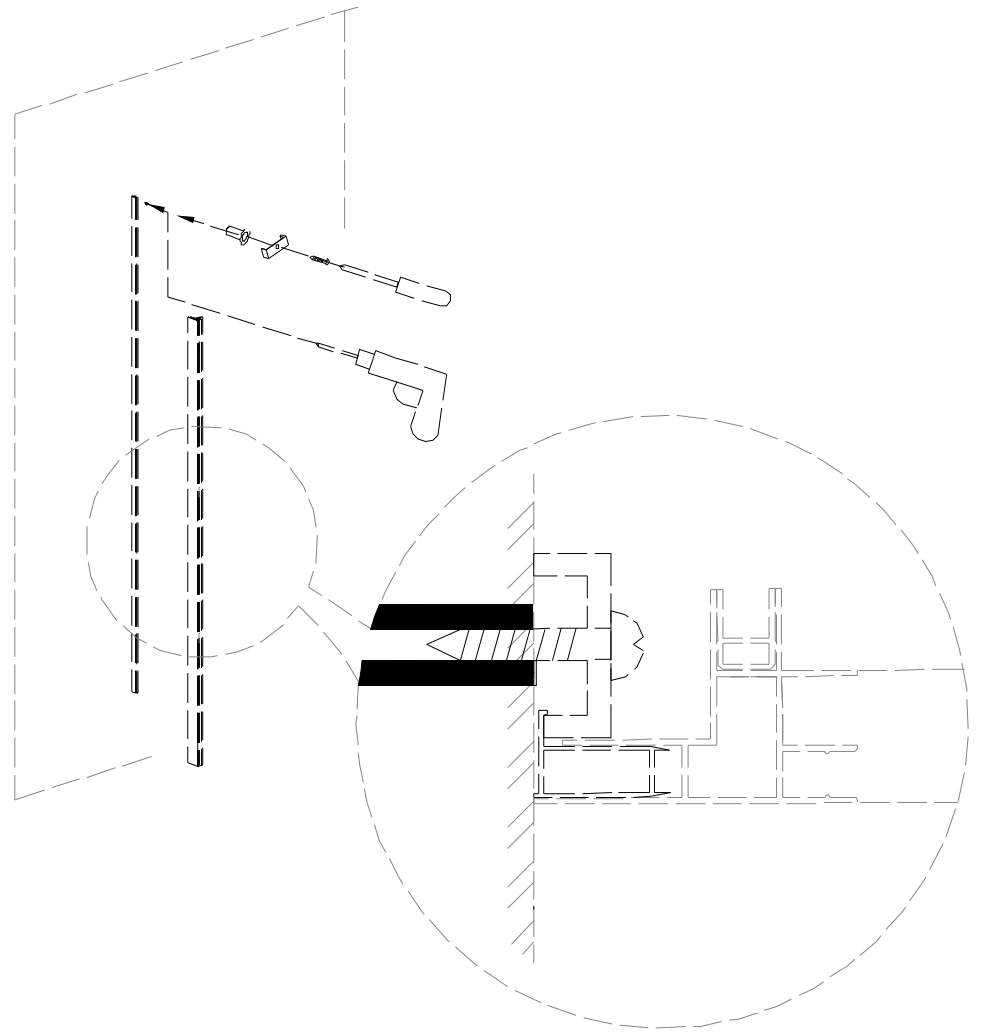
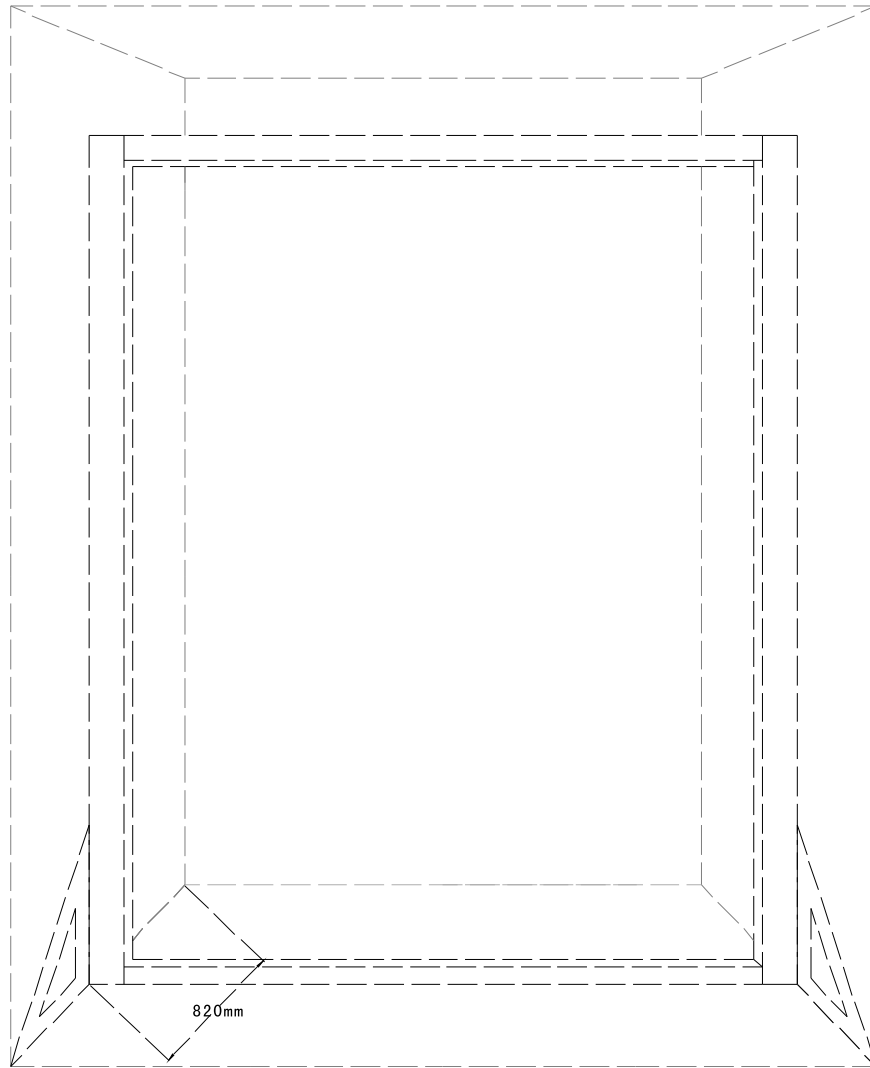

2. Install door frame

Drill holes on Wall A and Wall B and input inflating nut. Get the door frame fixed to the wall with tapping screws and blocks.

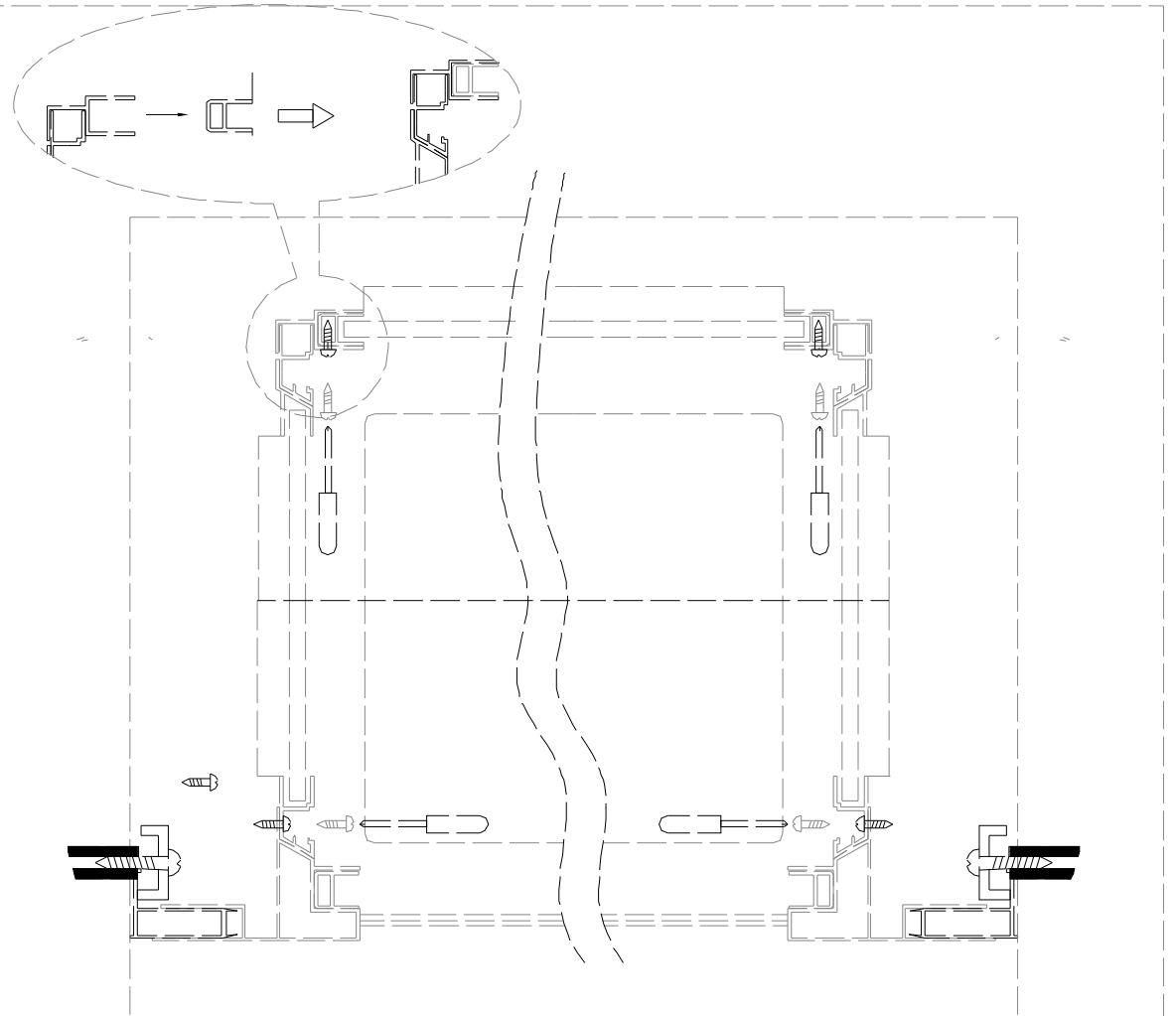
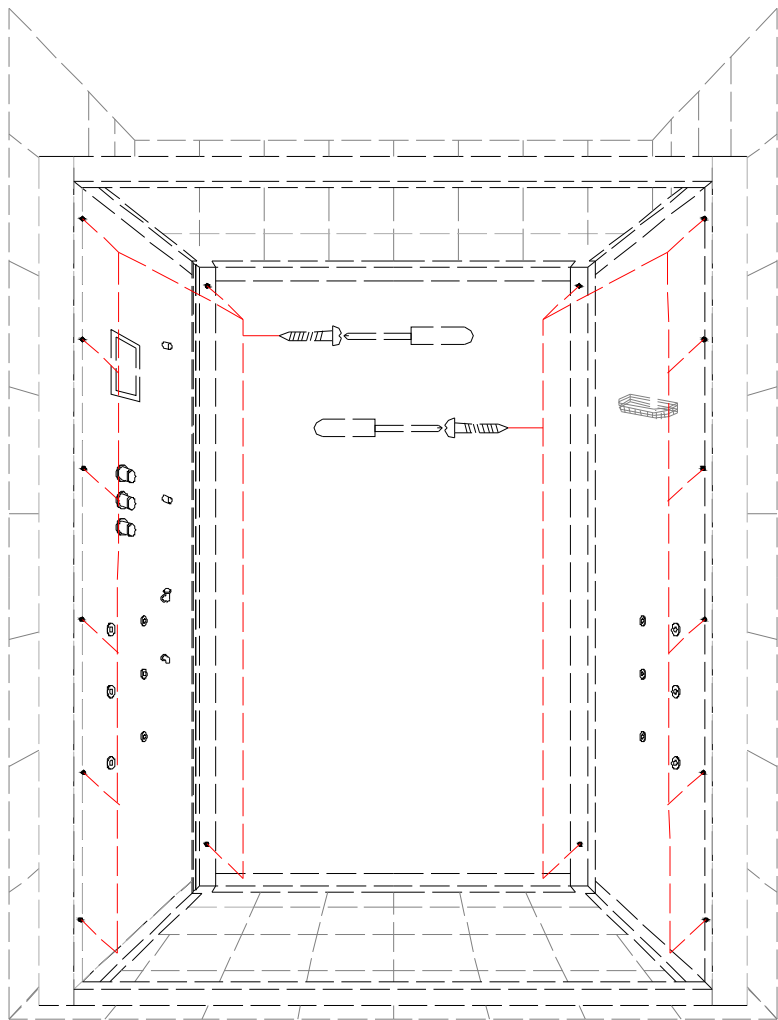

3. Install the body

- A. Get power supply and water supply connected;
- B. Get body connected with tapping screws.

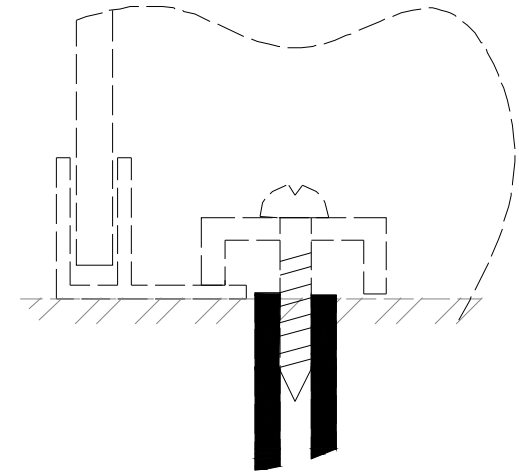
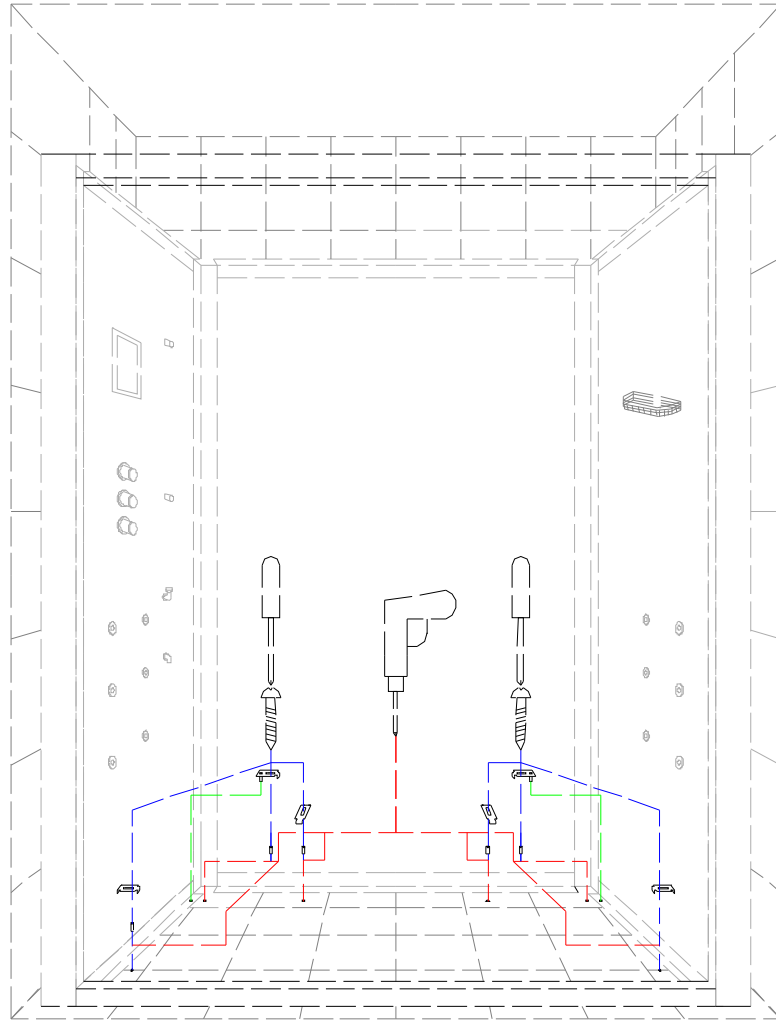

4. Get the body fixed to the floor

A. Drill holes on the floor;

B. Get the body fixed to the floor with tapping screws and blocks.

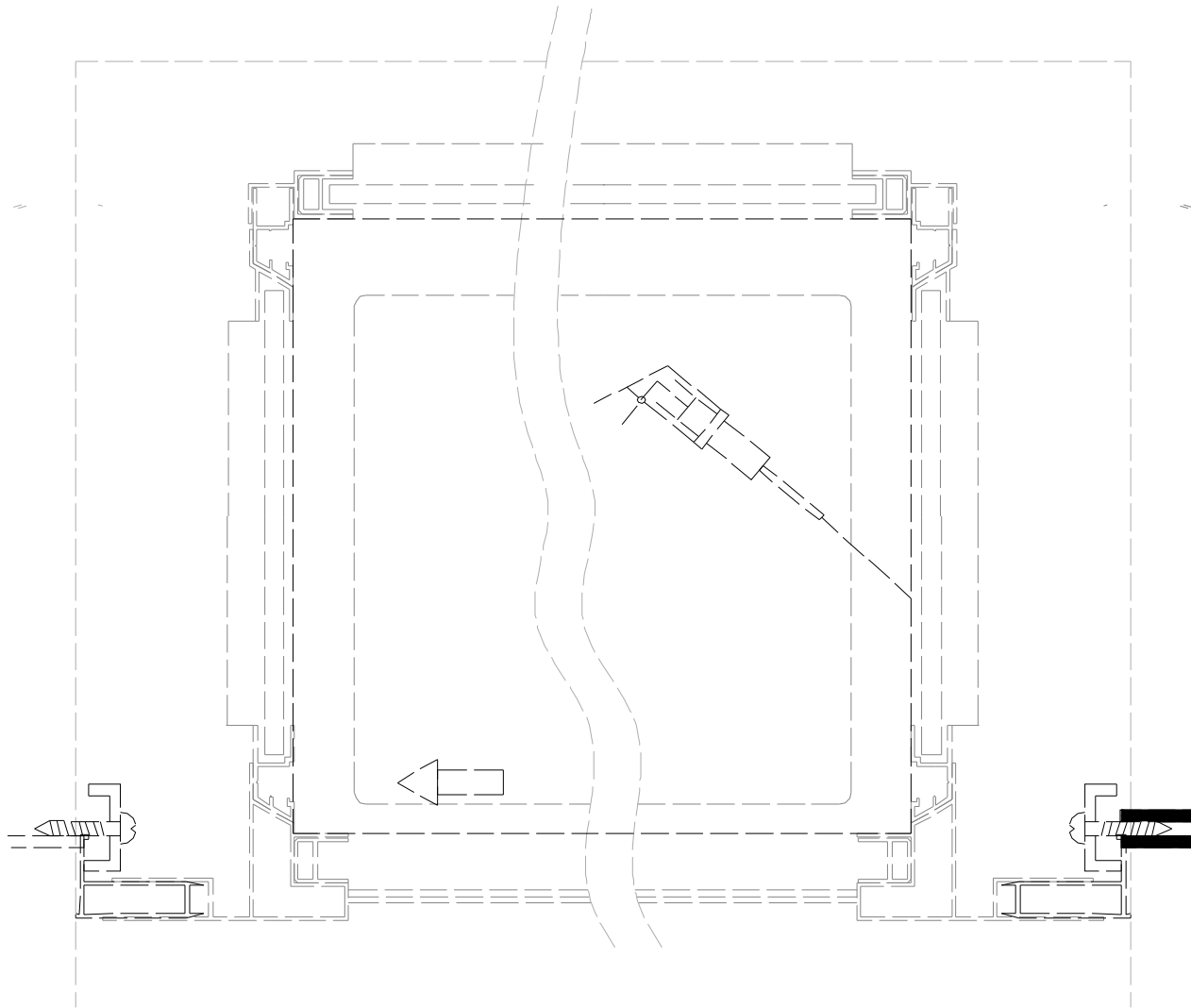

5. Apply silicone to seal the gap between body and floor.

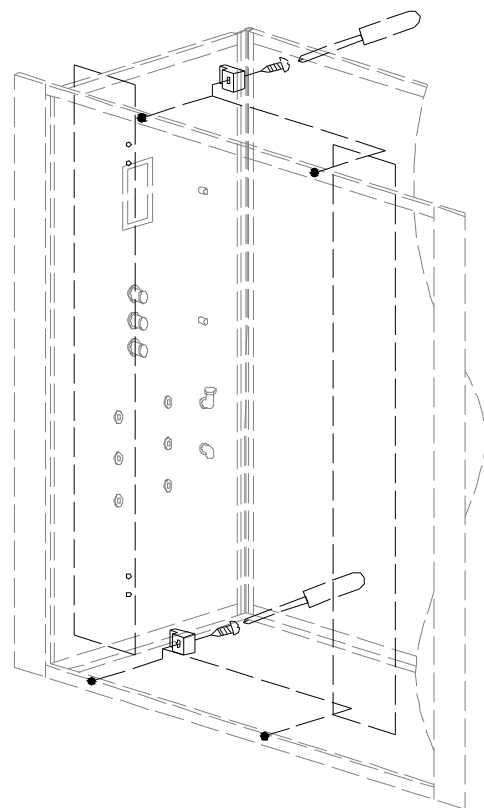

6. Install the fixed glass.

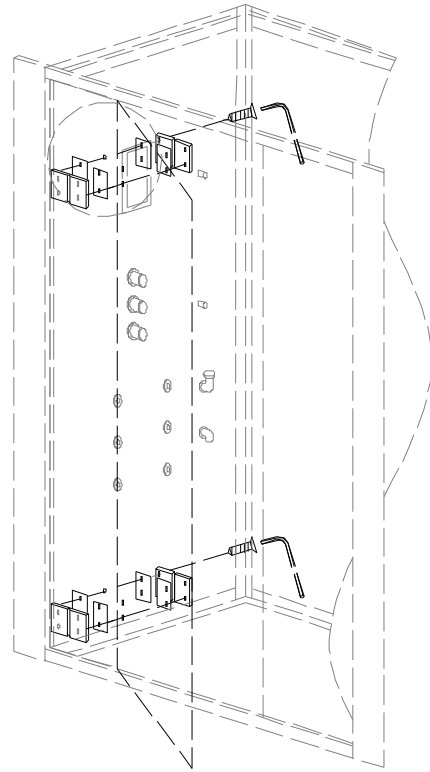

7. Install the removable glass door.

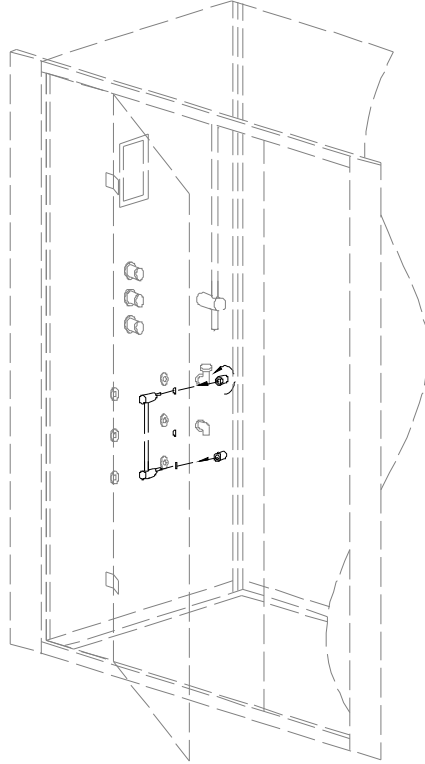

8. Install door handle

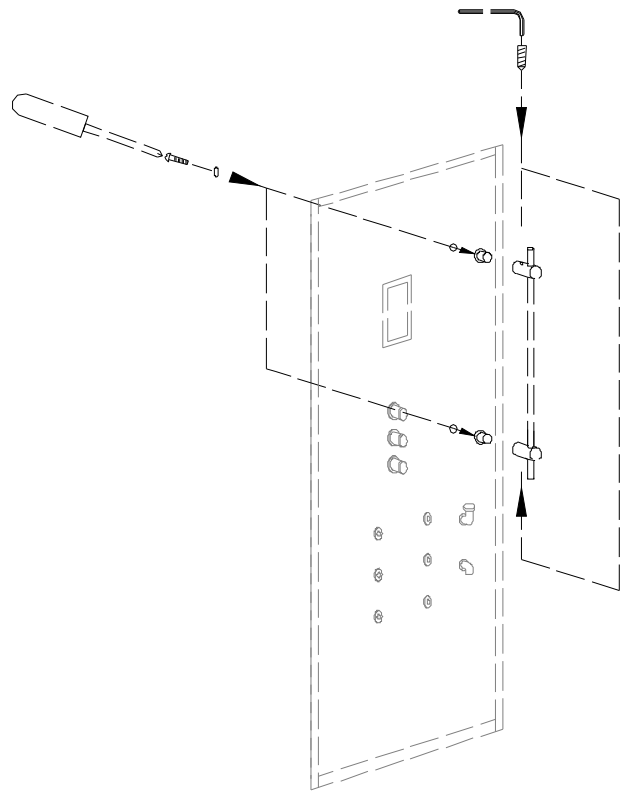

9. Install sliding bar for hand shower.

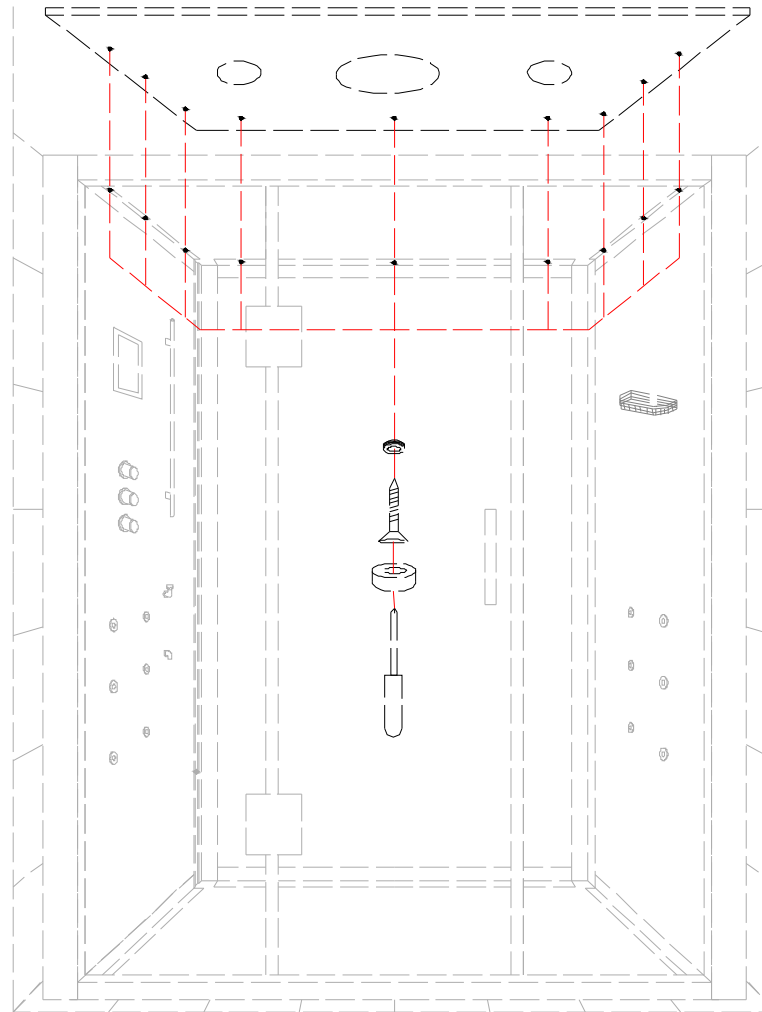

10. Install cover

- A. Get water supply and power supply connected;
- B. Get cover installed with tapping screws. And screw down the decoration cap.

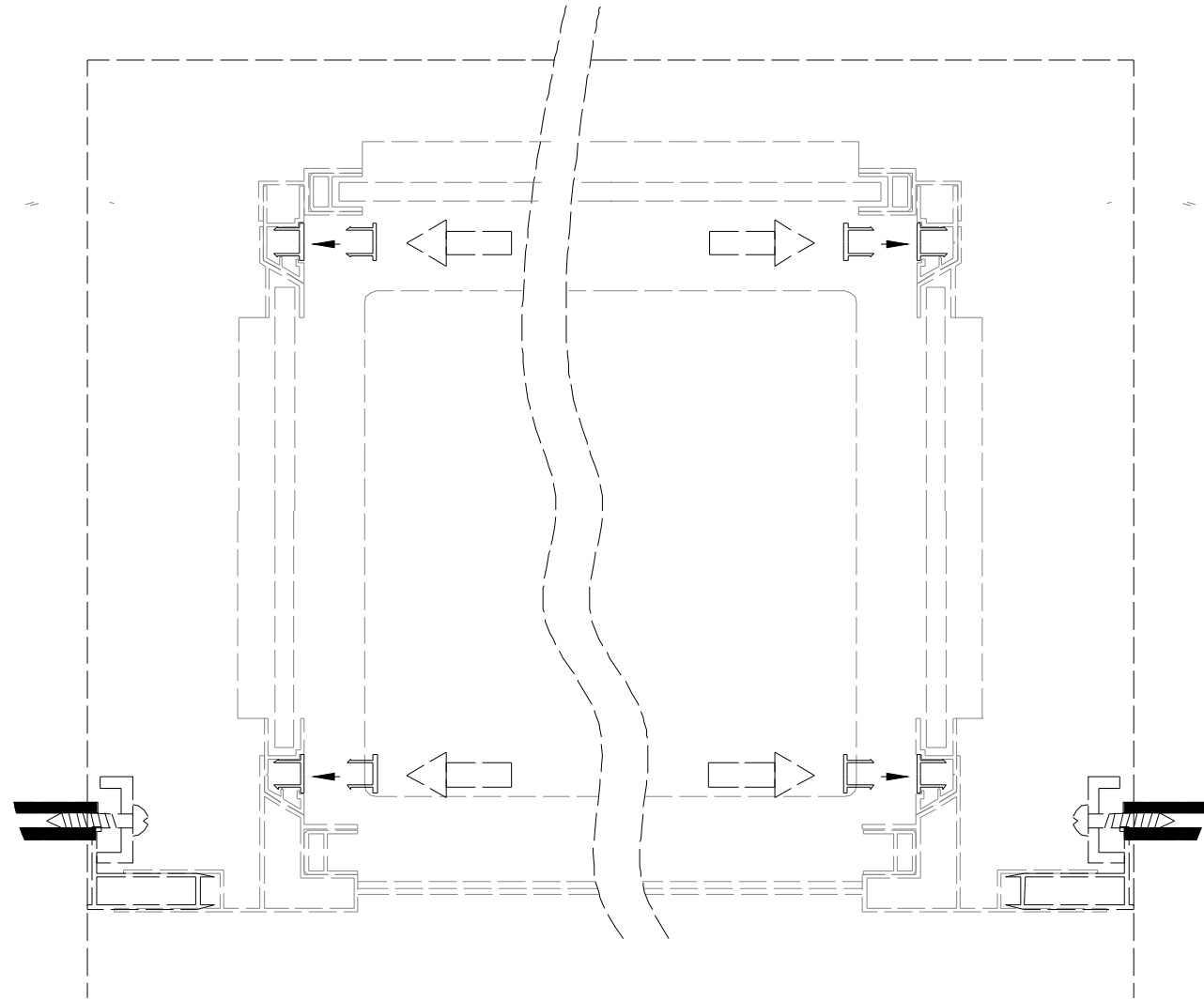
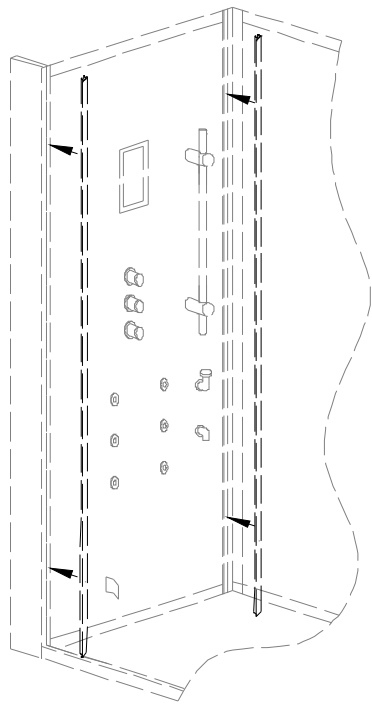

11. Install the decoration aluminum profile.

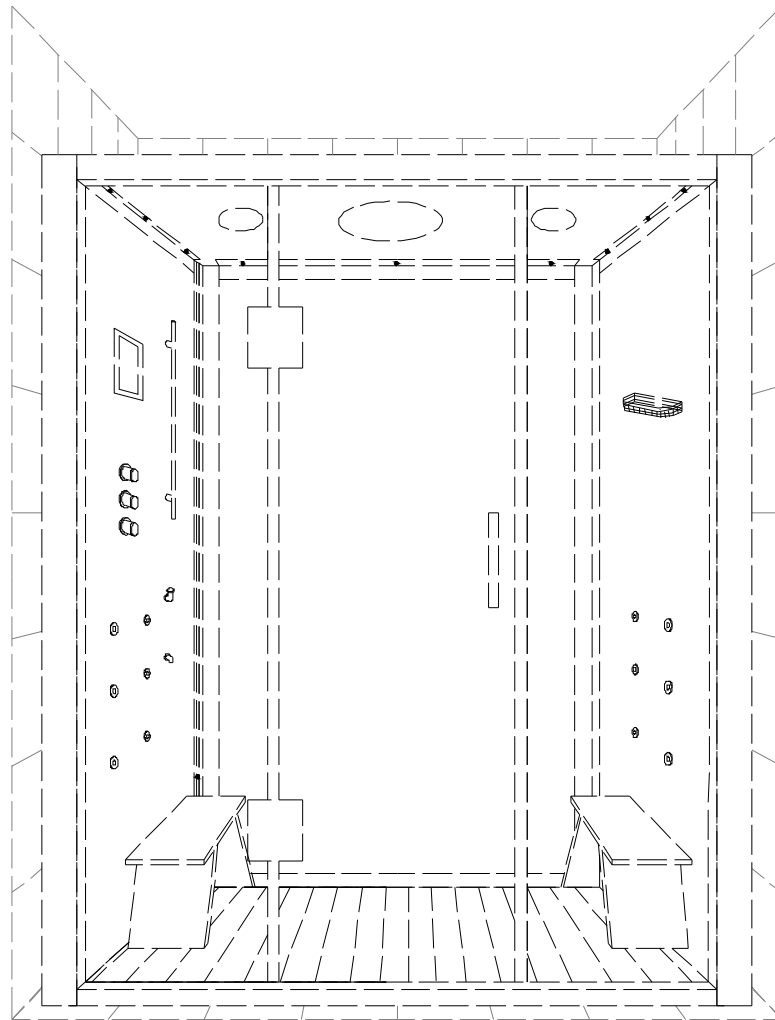

12. Put in the shower grid and seat. No using within 24 hours until the silicone is fully solid.