

~ 1 ~

Steam Shower Manual

Model: FJ-344



Important Safety Information

IMPORTANT

The following must be observed for safe and proper installation and operation. Professional installation is recommended; faulty electrical work may increase the risk of fire.

1. Always consult with a physician before using a steam shower.
2. Children should never use steam shower without adult supervision.
3. If you become dizzy, lightheaded or nauseas you should discontinue use immediately and consult a physician.

WARNING: Individuals who are intoxicated, or have been diagnosed with high blood pressure, or other heart problems should not use steam showers without prior medical consent.

Table of Contents

Notice.....	4
Features.....	5
Water & Electrical Connections	5
Installation	6

Notice

- Do not disconnect any hose or joints from the acrylic panels.
- All shower panel seams must be sealed with 100% silicone caulk
- Remove all protective plastic before assembly
- Tighten and reseal any and all loose fittings, jets and fixtures.
- All electrical work should be done in accordance with local safety standards.
- Water lines must be active before unit is powered up.

Features

- Luxurious Tempered Glass Enclosure
- Self-cleaning Steam Generator
- Body Massage Jets
- Rainfall Showerhead
- Molded Seat
- Aromatherapy Cup
- Computer Panel
- Quartz Light
- FM Radio / CD-MP3 connection
- Mirror
- Accessory Rack
- Handheld Showerhead

Water and Electrical Connections

- To avoid scalding the incoming water temperature should never exceed 122° Fahrenheit.
- Water pressure must stay within the range of 30-70 PSI.
- 2 Hot/Cold shutoff valves with ½ male pipe threads are required (not included).
- 1-220 volt 20 amp GFCI breaker with internal neutral wire is required (10-2/ 12-2 gauge wire).

Installation

Required tools

- Crescent wrench
- #2 Philips head screw-driver (electric if possible)
- Strait head screw-driver
- Level
- Caulk gun with 100% silicone caulk
- Customer support—call 866-STEAM-61
- **It is recommended to use 100% silicone caulk to seal all joints between shower panels instead of adhesive tape**

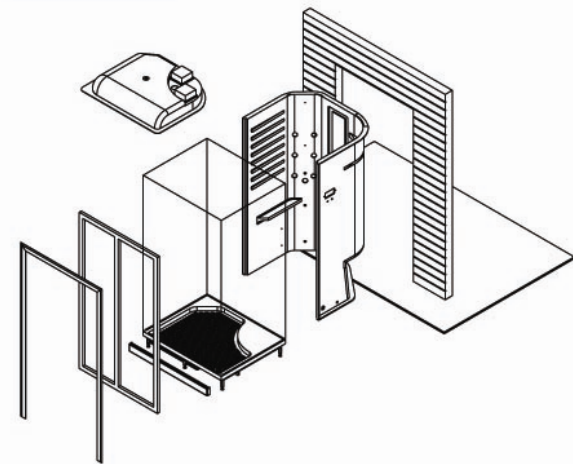
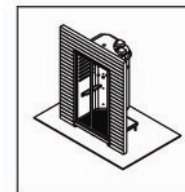

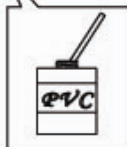
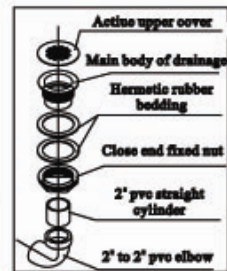
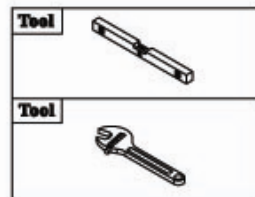

1. Install the base, silicon glue to prevent the leakage.

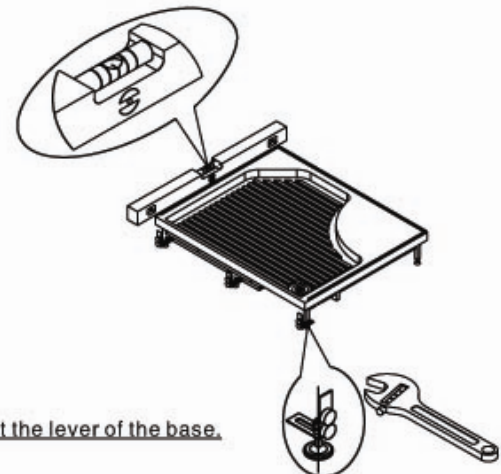

2. Adjust the lever of the base.

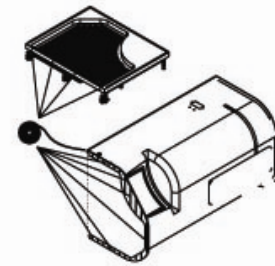
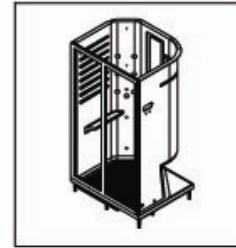

1. Stick the adhesive tape on the connective part to the base and bathtub-seat.

Tool	
	Rubber washer\stainless steel washer\crossing head screw ST4. 8X25
	M4 nut\stainless steel washer\plastic washer\stainless steel crossing head self-tapping screw M4X35
	ST4. 8X50



2. Pull up rubber belt of door frame.

3. Connected to the door frame and bathtub-seat.

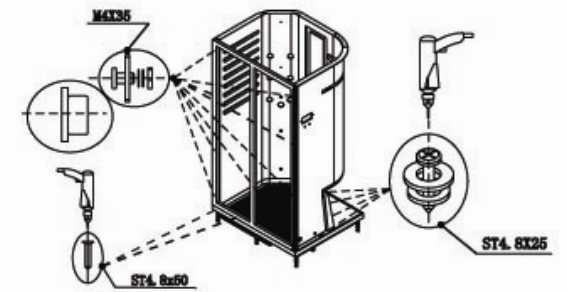

4. Put to the right holes then screw the screws tight.

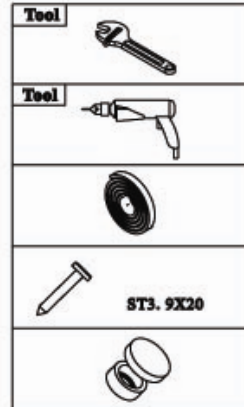
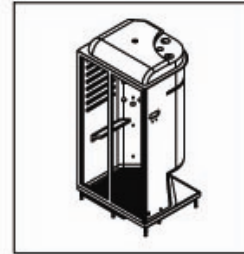

1. install the top showerhead

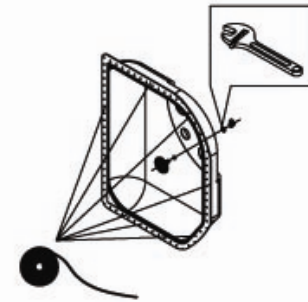

2. Stick the adhesive tape on the connective part to the top cap and bathtub-seat.

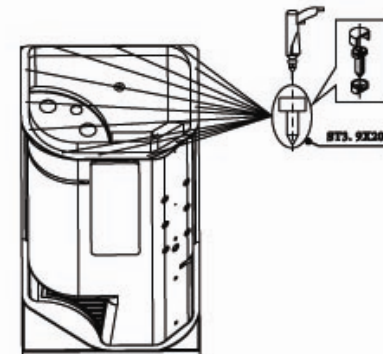

3. Put to the right holes then screw the screws tight.

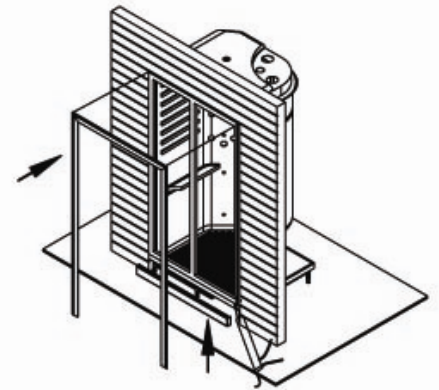
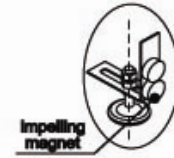
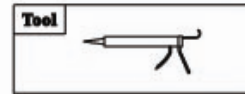
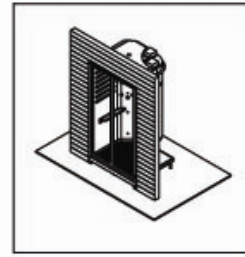

⚠ Silicon glue: prevent the leakage of the corner.